

10-115802

Play & Park Structures

This play equipment is recommended for children ages: 2-5

Minimum Area Required: 26'-5" x 22'-1"

Scale: 1/4" = 1'-0"  
This drawing can be scaled only when in an 11" x 17" format

Drawn By:

Date: 4/12/2018

Quote Number: 10-115802

play&park structures

A PLAYCORE Company

544 Chestnut Street  
Chattanooga, TN 37402  
800-727-1907 / www.playandpark.com



Total Play Components	8		
Elevated Play Components	6		
Elevated Play Components Accessible by Ramp	0	Req.	0
Elevated Components Accessible by Transfer	6	Req.	3
Accessible Ground Level Components Shown	2	Req.	2
Different Types of Ground Level Components	2	Req.	2

User Capacity	20-30
Critical Fall Height	4'-0"

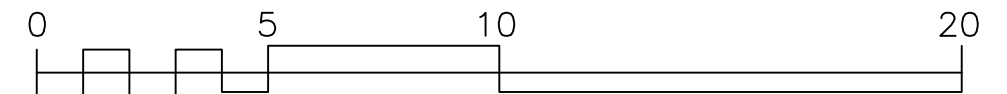
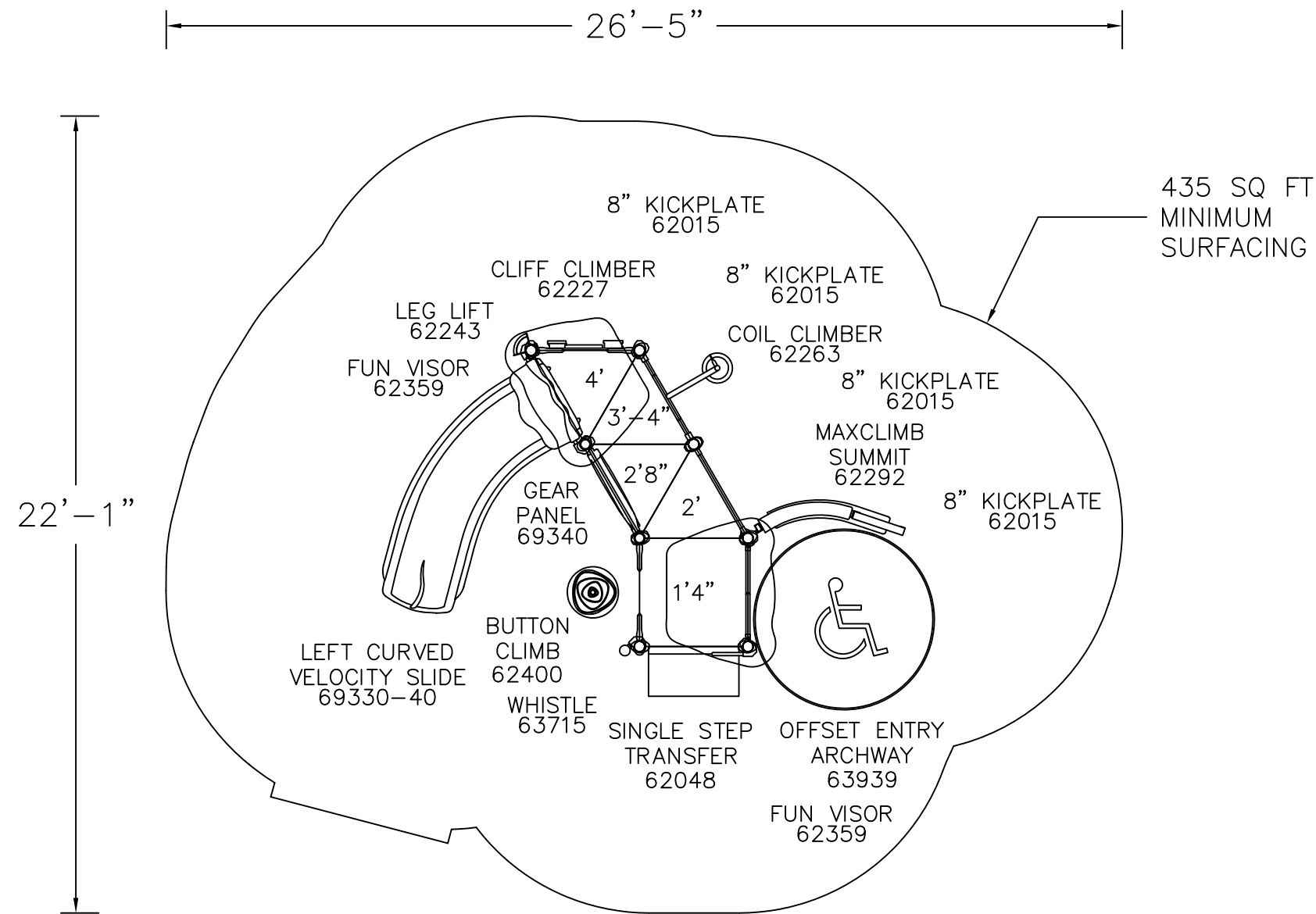

It is the manufacturer's opinion that the structure shown herein complies with current ada standards concerning accessibility if used with proper accessible surfacing and together with other necessary ground level play equipment.  
**IMPORTANT:** Never install play equipment over hard, unresilient surfaces such as asphalt, concrete, or compacted earth. It is the owner's responsibility to ensure the "minimum area required" contains an appropriate amount of resilient material to cushion accidental falls.